



# BOOKSHELF

[thatsmyletter.blogspot.com](http://thatsmyletter.blogspot.com) for [Remodelaholic.com](http://Remodelaholic.com)

## Supplies:

1 sheet -  $\frac{3}{4}$ " plywood  
1/2 sheet -  $\frac{1}{4}$ " plywood  
4 - 2x2x8 boards  
1 - 1x2x6 pine board  
4 - feet  
16' cove moulding (optional)

2  $\frac{1}{2}$ " & 1  $\frac{1}{4}$ " pocket hole screws  
1  $\frac{1}{4}$ " wood screws  
wood glue  
 $\frac{3}{4}$ " finish nails

## Cut List:

2 -  $\frac{3}{4}$ " plywood @ 29  $\frac{3}{4}$ " x 9" (sides)  
1 -  $\frac{3}{4}$ " plywood @ 31  $\frac{1}{2}$ " x 9" (bottom)  
1 -  $\frac{3}{4}$ " plywood @ 36" x 13" (top)  
2 -  $\frac{3}{4}$ " plywood @ 31  $\frac{1}{4}$ " x 12" (shelves)  
4 - 2x2 @ 9" (short trim)  
4 - 2x2 @ 32  $\frac{3}{4}$ " (long side trim)  
4 - 2x2 @ 31  $\frac{1}{2}$ " (bottom & top trim)  
3 - 1x2 @ 9" (top cross support)  
1 -  $\frac{1}{4}$ " plywood @ 32  $\frac{3}{4}$ " x 34  $\frac{1}{2}$ " (back)

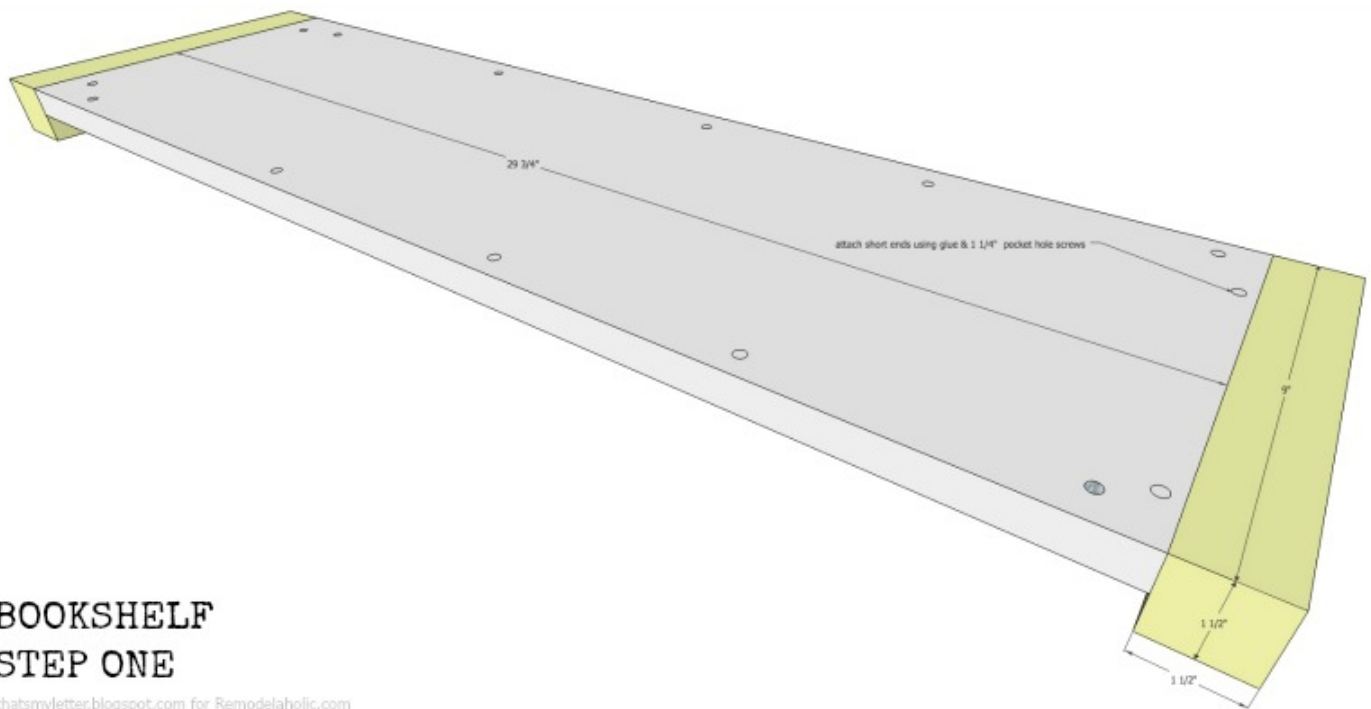

## BOOKSHELF STEP ONE

[thatsmyletter.blogspot.com](http://thatsmyletter.blogspot.com) for Remodelaholic.com

**Step 1:** Attach short end trim to sides using glue and 1 1/4" pocket hole screws.  
Make 2.

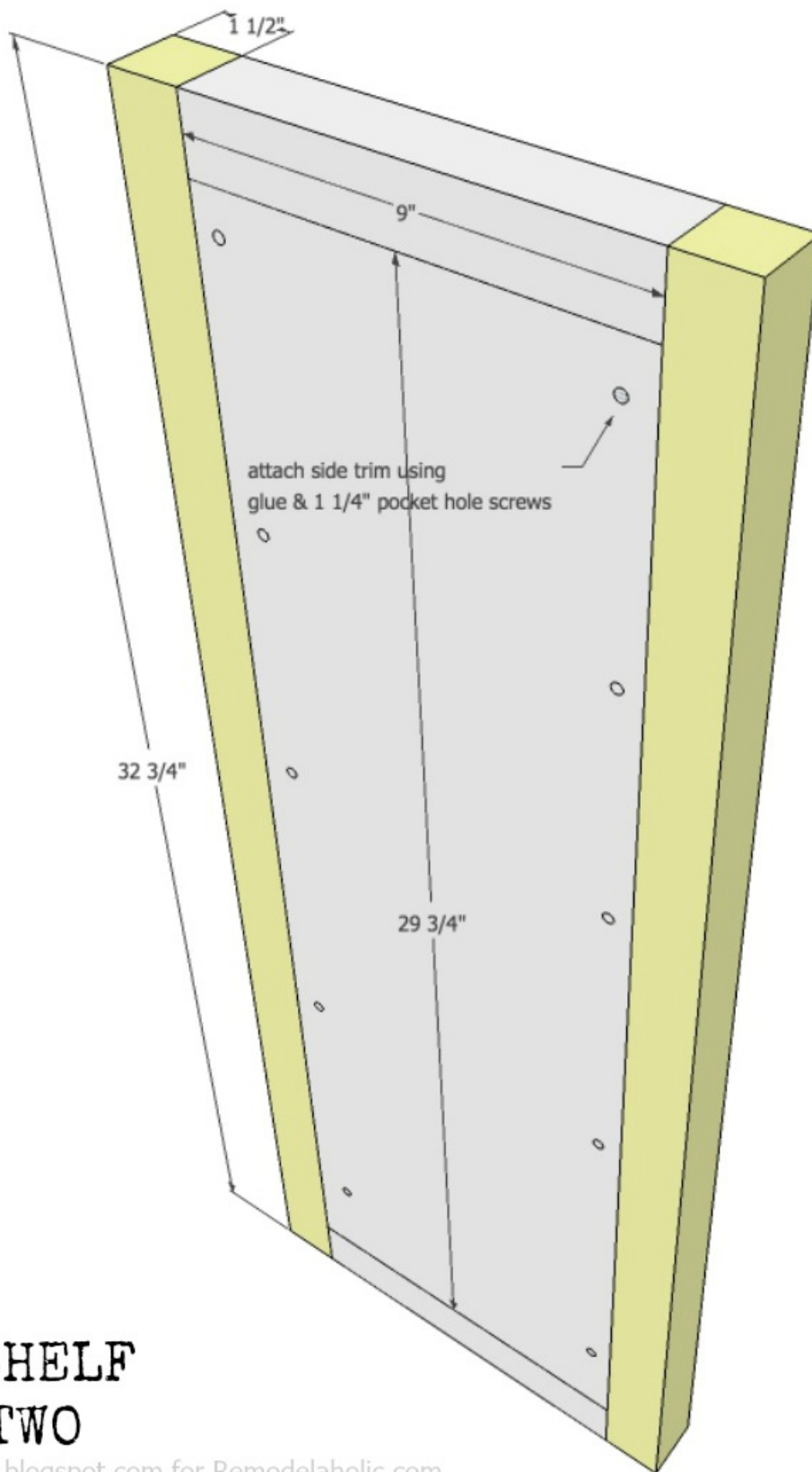

## BOOKSHELF STEP TWO

[thatsmyletter.blogspot.com](http://thatsmyletter.blogspot.com) for [Remodelaholic.com](http://Remodelaholic.com)

**Step 2:** Attach long trim to sides using glue and 1 1/4" pocket hole screws.

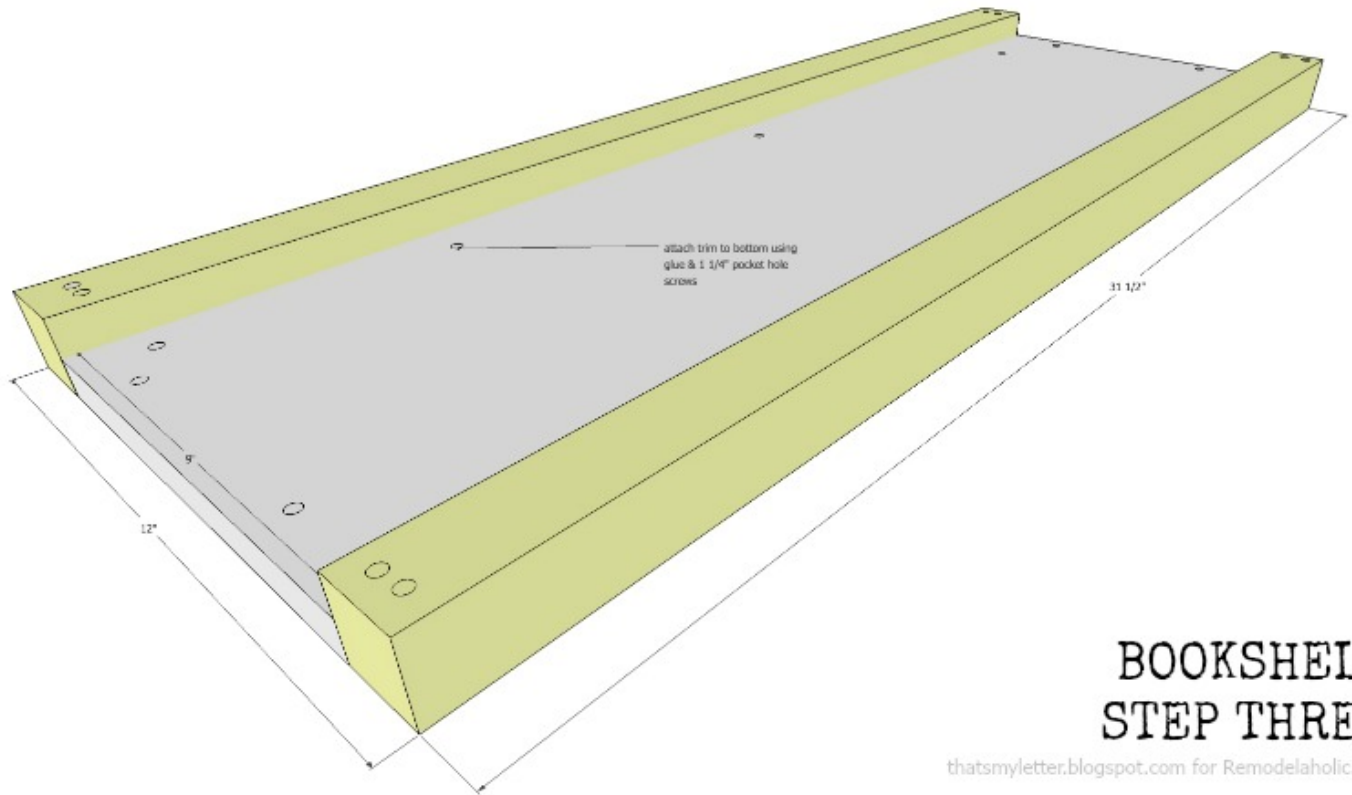

## BOOKSHELF STEP THREE

[thatsmyletter.blogspot.com](http://thatsmyletter.blogspot.com) for Remodelaholic.com

**Step 3:** Attach front and back trim to bottom piece using glue and 1 1/4" pocket hole screws.

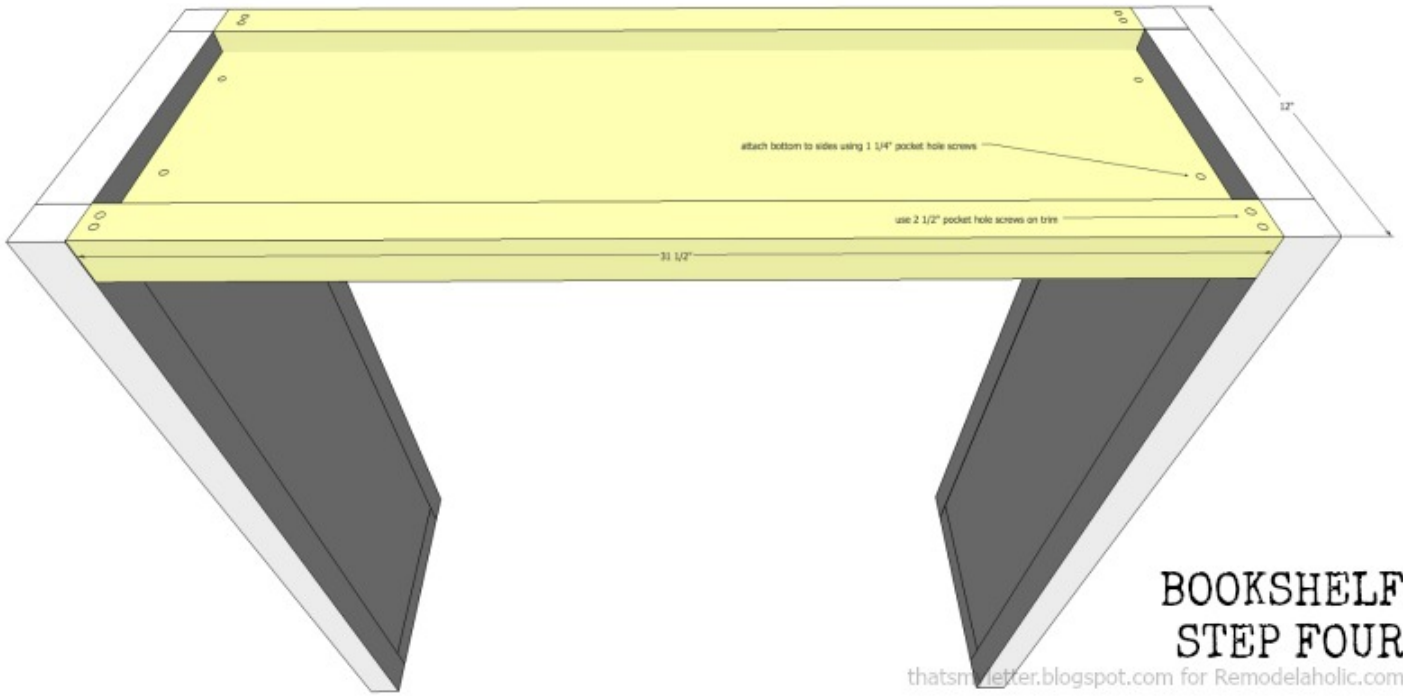

**Step 4:** Attach bottom to sides using glue and pocket hole screws at all joins.

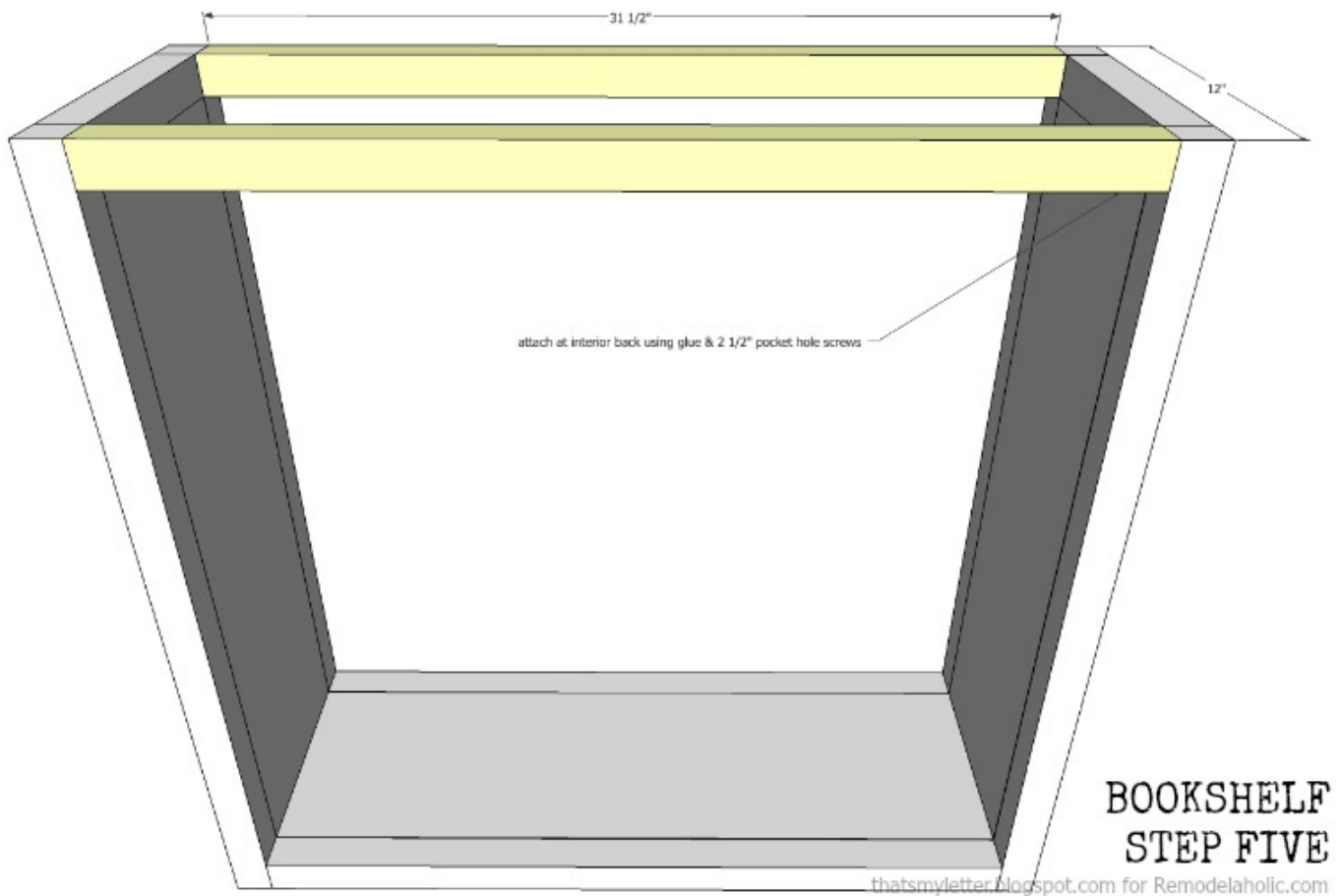

**Step 5:** Attach top trim, front and back as shown. Keep pocket holes towards back or top and use glue and 2 ½" pocket hole screws.

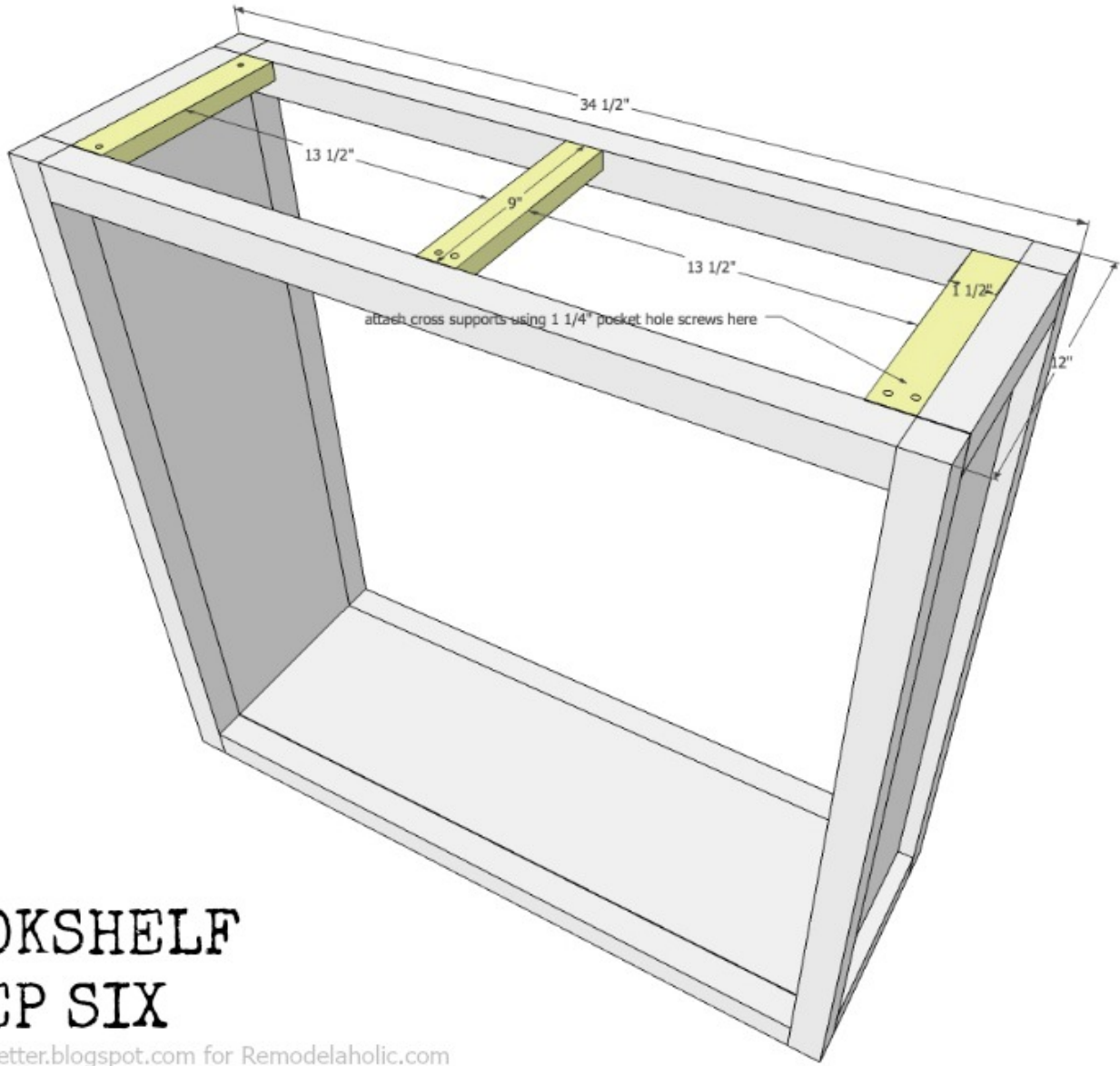

# BOOKSHELF STEP SIX

[thatsmyletter.blogspot.com](http://thatsmyletter.blogspot.com) for [Remodelaholic.com](http://Remodelaholic.com)

**Step 6:** Attach top cross support pieces using glue and 1 1/4" pocket hole screws.



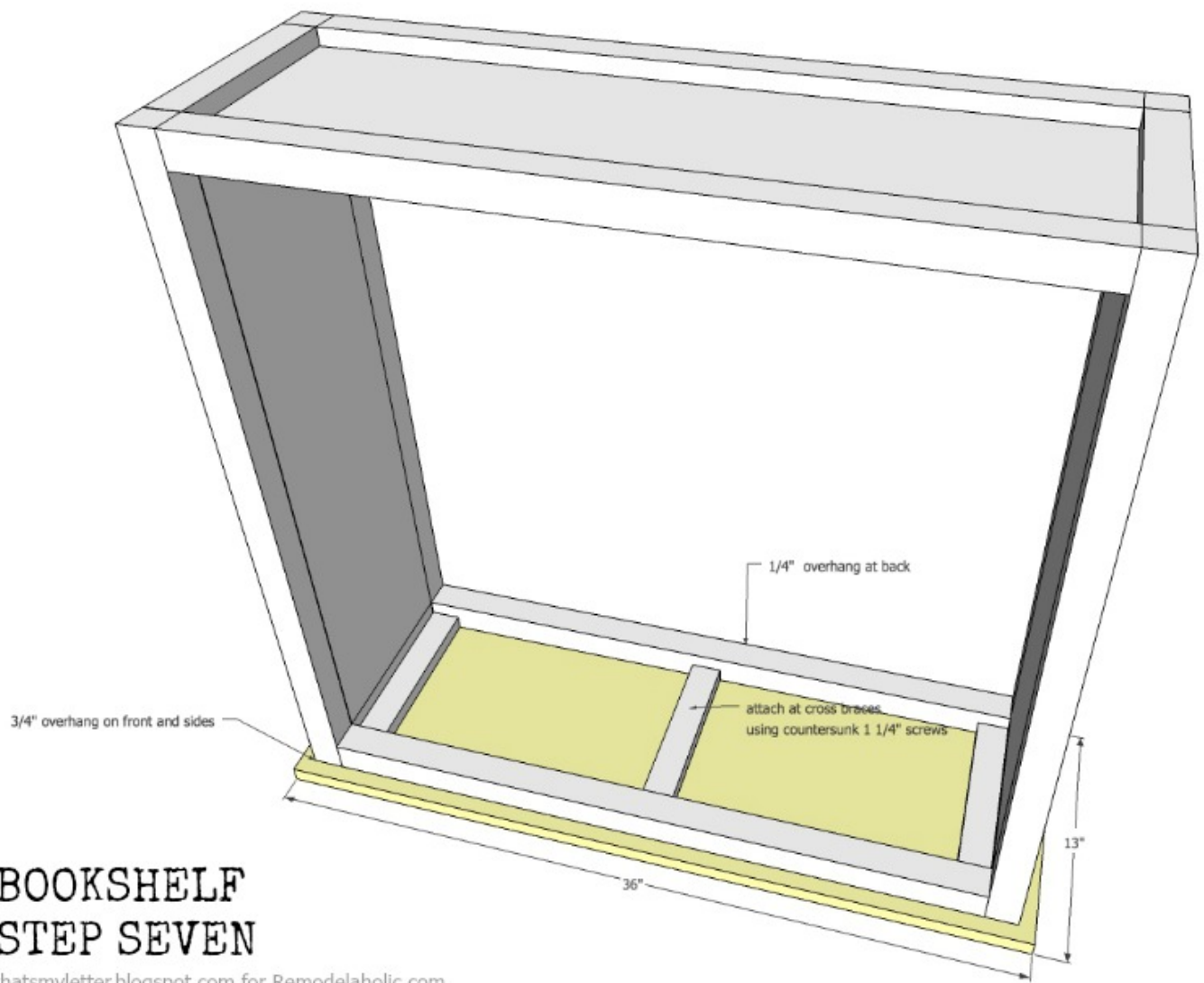

## BOOKSHELF STEP SEVEN

thatsmyletter.blogspot.com for Remodelaholic.com

**Step 7:** Attach top to cross supports centering with  $\frac{3}{4}$ " overhang at front and sides,  $\frac{1}{4}$ " at back. Use glue and countersunk  $1 \frac{1}{4}$ " screws.

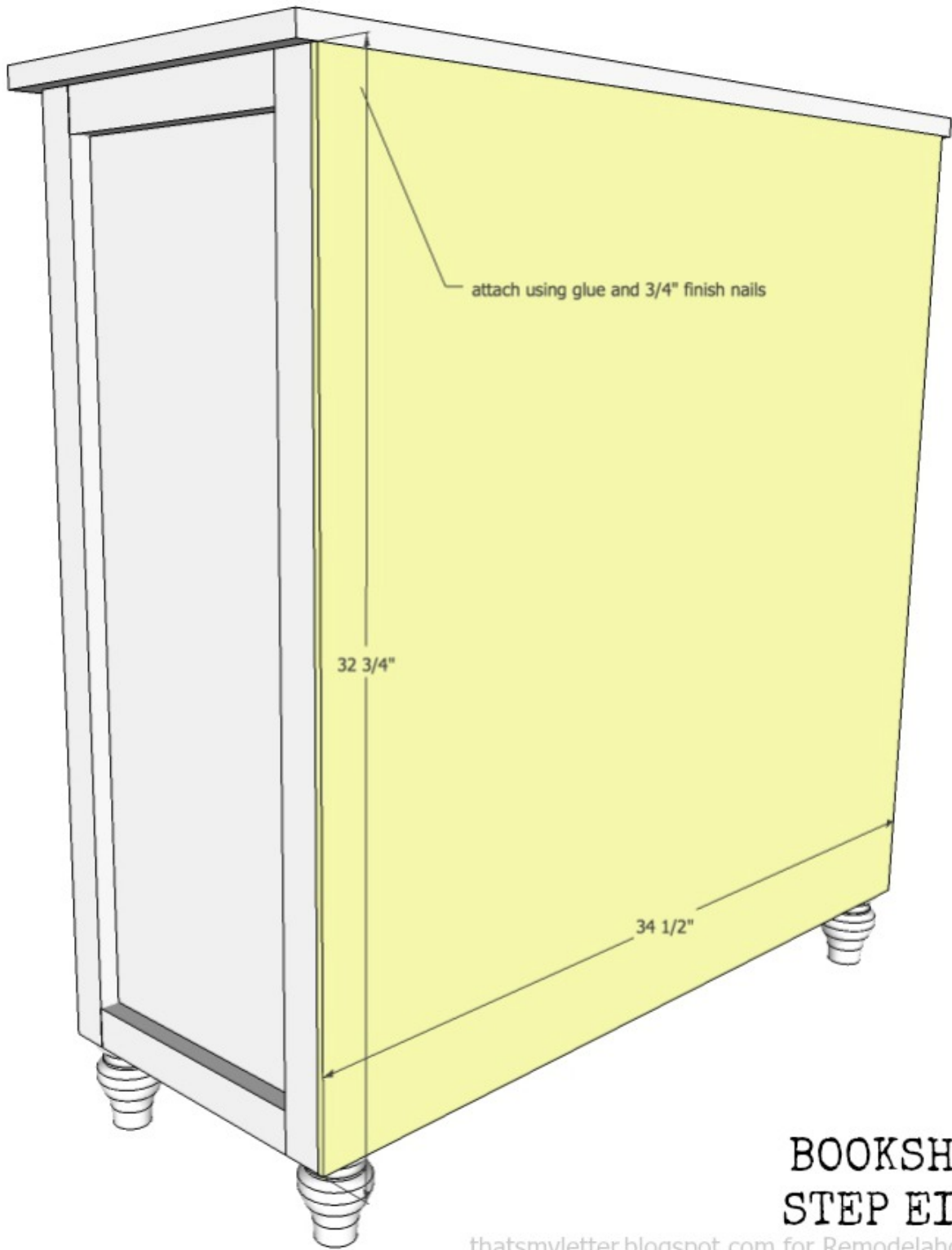

## BOOKSHELF STEP EIGHT

[thatsmyletter.blogspot.com](http://thatsmyletter.blogspot.com) for [Remodelaholic.com](http://Remodelaholic.com)

**Step 8:** Attach back using glue and 3/4" finish nails.